



Operating instructions

(Translation of the original operating instructions)

ViroLine Smart

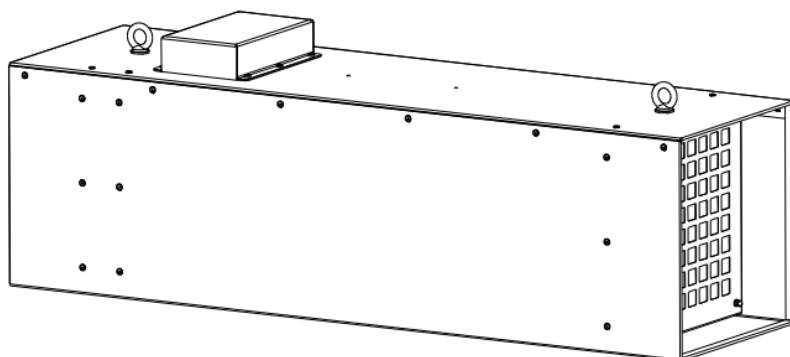

Table of contents

1. General	3
2. Description of the system elements	4
2.1. Illustration of the system elements	4
2.2. Functionality of the system	5
2.3. Intended use	5
2.4. Residual risk	5
3. Safety instructions	6
3.1. Definition of the hazard symbols	6
3.2. General safety instructions	6
4. Storage, transport and installation of the device	7
5. Commissioning	8
5.1. Electrical connection	8
5.2. Integration in the WLAN and app ("WiFi" version)	8
5.3. Attach the plug	11
6. Operating the system	12
6.1. Explanation of the operating elements	12
7. Maintenance	13
7.1. Reset to maintenance state	14
7.2. Replacing the microfilter mats	14
7.3. Replacing the UV-C lamp	15
8. Dismantling / Disposal	16
9. Diagnostics and troubleshooting	16
10. List of spare parts	17
11. Technical data	17
12. EC declaration of conformity	18
13. Training protocol	19
14. Maintenance intervals	20
14.1. Usage-related maintenance	20
14.2. General maintenance	20
14.2.1. Visual inspection of the device	21
14.2.2. Functional test of the device	21
14.2.3. Electrical test of the electrical lines and earthing connections	21

1. General

Congratulations on purchasing the product from TEKA.

Our engineers ensure that our devices reflect the state of the art through continuous development. Nevertheless, misuse or misconduct can endanger your safety. Please observe the following for a successful use of the device:



Only authorised and instructed personnel can carry out transport, operation, maintenance and repair of the device. The operator must ensure that the operating personnel take note of these instructions.

Please read these instructions before operating the device, and observe the safety precautions to avoid injury!

Store this manual in a safe place! These instructions are to be regarded as a component of the product!

Adhere to all product notes!

Modifications or conversions that the operator carries out at the device without the consent of the manufacturer, can lead to new safety hazards or to the loss of warranty claims.

Observe the manufacturer's instructions. Contact the manufacturer in case of any uncertainty:

Tel: +49 2541-84841-0

E-mail: info@teka.eu

2. Description of the system elements

2.1. Illustration of the system elements

Installation example:

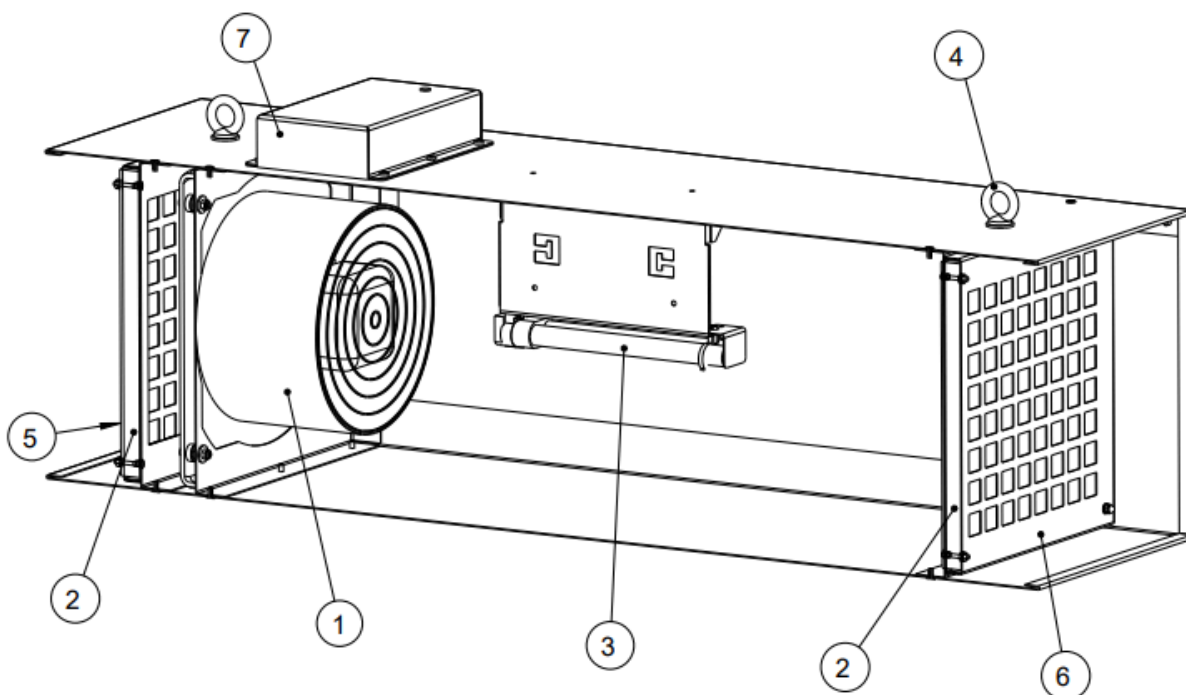

Z.Nr. 20393701

Pos.1	Fan	Pos.5	Suction grille
Pos.2	Microfilter mats (2 pieces)	Pos.6	Exhaust grille
Pos.3	UV-C lamp	Pos.7	Mains cable with plug
Pos.4	Fastening eyelet		

2.2. Functionality of the system

A fan admits the air. The contaminated air is guided through a microfilter into the stable housing. In the housing, the germs are efficiently eliminated by means of a high-performance UV-C lamp. In this way, the device progressively cleans all the air in the room.

2.3. Intended use

The device is intended for commercial use. If the device is made publicly accessible, it must never be operated unsupervised by authorized personnel, authorized by the operator.

The filter unit is intended to clean the ambient air from germs, bacteria and viruses.

	WARNING
<p>Improper use can damage parts and be a danger to life and limb! The device must not be used for the extraction of oil-laden welding fume, explosive dust and gases, hybrid mixtures, glowing or burning substances, gases, water, etc. The device must not be operated in explosive zones.</p>	

2.4. Residual risk

	CAUTION
<p>Danger due to possible hazardous materials in the exhaust air flow. Because the unit does not monitor the quality of the air in the exhaust air flow, we recommend that you always guide the exhaust air flow exiting our unit to areas (e.g. to the outside into the open air) in which there is no danger to any living being. To do this, it is necessary to fit a suitable exhaust air line at the filter unit.</p>	

3. Safety instructions

3.1. Definition of the hazard symbols

The device is constructed according to the state of the art and the recognised safety regulations. Nevertheless, during use threats to life and limb of the user or other persons may arise. The impairment of the machine or other property are also possible. In these instructions we warn by using corresponding indications.

	WARNING
	<p>WARNING These instructions are made in case of risks that can lead to <u>injury or death</u>.</p>

	CAUTION
	<p>CAUTION These instructions are made in case of risks that can lead to <u>injury</u>.</p>

	NOTICE
	<p>NOTICE These instructions are made in case of risks that can lead to <u>material damages</u>.</p>

	Information notes are no hazard warnings; they call attention to useful information.
---	--

3.2. General safety instructions

	WARNING
	<p>Dangers arising from improper use / unauthorised operations. The operator must ensure that their authorised personnel are familiar with all the safety indications in this manual in advance. The operator is responsible for ensuring that all work is carried out by authorised and qualified personnel. We therefore recommend using the training protocol on the last page for that purpose (see chapter "Training protocol"). Laymen are allowed to operate the device after having received the necessary instructions. But they are not allowed to carry out any installation, repair or maintenance work. The operator must ensure that the device is not operated, opened, serviced or otherwise confiscated by minors (persons younger than 18 years).</p> <hr/> <p>Dangers arising from fire. In case of fire, if possible, switch the unit immediately off or disconnect it from the power supply. Fire extinguishing measures which the operator is obliged to determine beforehand must be initiated immediately.</p>

	WARNING
	<p>Dangers arising from electricity. The operator must ensure that electrical plants and equipment are only built, modified and maintained by a qualified electrician or under the direction and supervision of a qualified electrician. Do not work on components if you are not sure that these are disconnected. If necessary, disconnect the device from the electric power supply and secure it against unauthorized restarting.</p>

4. Storage, transport and installation of the device

	WARNING
	<p>Risk of injury from tilting or unmounted components when stored or transported. The device must be secured against tilting and slipping when it is stored or transported. Do not stand under or next to the floating load. Lift trucks, forklift trucks and transport cranes must have a sufficient minimum load bearing capacity.</p> <hr/> <p>Risk of injury arising from the falling unit at its destination. The unit must be firmly mounted under the destined ceiling. The ceiling must be vibration-free and horizontal. The operator must check if the ceiling provides a sufficient bearing capacity. The “WiFi” version of the device first has to be commissioned before being installed below the ceiling, see chapter “Commissioning”.</p>

	NOTICE
	<p>Damage or functional impairment of the unit due to climatic influences. The unit must be stored in a dry place and protected against moisture during transport. As a matter of principle, the filter unit is not designed to be installed outside.</p>

5. Commissioning

	WARNING
	<p>Dangers arising from a defective condition of the unit. There is also a risk to the eyes if there is a direct view of the UV-C lamp.</p> <p>Make sure that the measures described in this chapter are completed before the commissioning of the unit. All required connections must be attached before turning the unit on. Do not operate the unit if any components are defective, missing or damaged. Check the orderly condition of the unit before switching it on. The unit must not be operated without a filter element.</p>





	NOTICE
	<p>Damaged supply lines.</p> <p>Make sure that the supply lines are protected against damage by forklift trucks and similar events. Protect all supply lines from heat, moisture, oil and sharp edges.</p>

5.1. Electrical connection

	NOTICE
	<p>Electric malfunction possible in cause of an incorrect power supply.</p> <p>Pay attention to the admissible supply voltage. Please observe the specifications on the type plate.</p>

- Connect the mains cable (see chapter 2.1) to the power supply.

5.2. Integration in the WLAN and app (“WiFi” version)

	<p>This section only applies</p> <ul style="list-style-type: none">• to the “WiFi” device version, not the “Basic” version,• <u>and</u> if the device version “WiFi” can be switched on and off via the app. This then requires the device to be integrated into the WLAN network and into the app.	
	<p>Integration in the WLAN is only possible if the network is set to 2.4 GHz. Otherwise the WLAN must be set to 2.4 GHz, for example in the router settings.</p>	
		
	 2.4GHz	 5GHz

Proceure:

- To control the “ViroLine Smart **WiFi**”, choose a terminal device that is already integrated in the existing WLAN. Alternatively, add the required terminal device to the WLAN.
- Download the required app “Smart Life - Smart Living” onto your terminal device:

	<p>Android: https://play.google.com/store/apps/details?id=com.tuya.smartlife&hl=de</p> <p>Apple: https://apps.apple.com/de/app/smart-life-smart-living/id1115101477</p>
---	---

- Start the App.
- Create a new account (A), or attempt to perform the operation without creating an account (B).

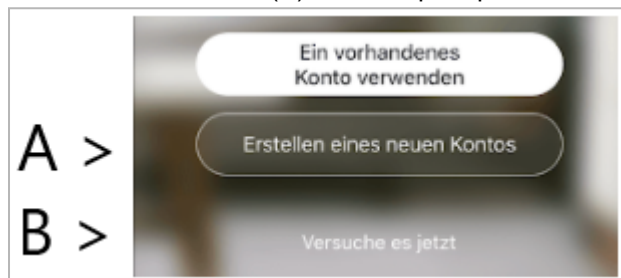

- Add a new device. Next, choose to change WLAN (WiFi).

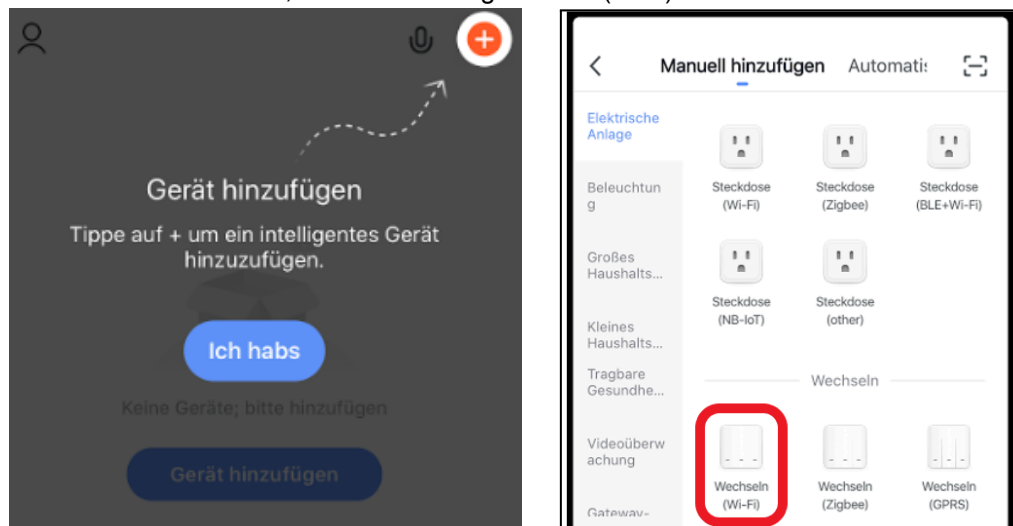

- Select your WLAN.

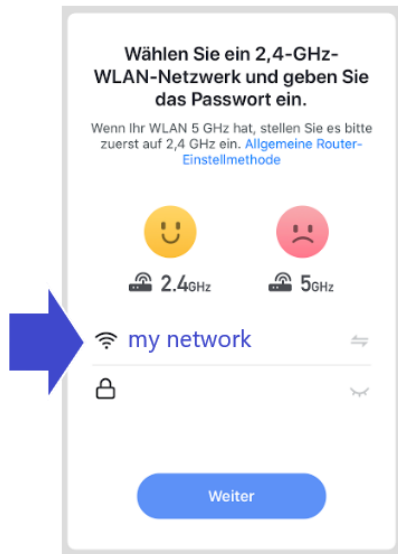

You now see a prompt telling you to reset the device. To do this, press the button (C) on the inside built receiver. Actuate this using the wooden stick supplied through the opening "A", so that the control lamp of the inside built receiver starts to flash quickly. As soon as the lamp starts to glow permanently, you must tick "Next Step" on the terminal device (1.) and press "Next" (2.).



- As soon as the device has been recognised, this is indicated on the terminal device.



- The device can then be attached to the intended location.



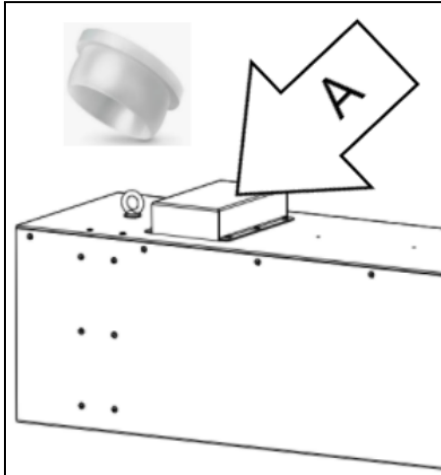

5.3. Attach the plug

The supplied plug $\varnothing 6$ mm must be attached to the opening "A" if not already done.



6. Operating the system

6.1. Explanation of the operating elements

Operating elements for the device control		
Representation	Designation	Description / function
	Version " Basic ": ON-OFF-switch	By means of this switch, the device is switched on and off. i When the device is switched off, it is <u>not</u> disconnected from the power supply. If the system does <u>not</u> switch on, check whether this is because a timer is being used.
	Version " WiFi ": ON-OFF-switch + App	By means of this switch, the device is switched on and off. Alternatively, the system can also be started using the app (see chapter "Commissioning"):  i When the device is switched off, it is <u>not</u> disconnected from the power supply. If the system does <u>not</u> switch on, check whether this is because a timer is being used. i When disconnected from the power supply, the system remembers the last operating state. When power is supplied again, the system may switch on directly.
	Timer	A timer is enclosed and may optionally be used. However, the system can also be used without this.



7. Maintenance

In accordance with national regulations, the operator is obliged to carry out repeat and functional tests. Unless otherwise specified by national regulations, we recommend regular visual inspections and functional tests of the device as described in the chapter “Maintenance intervals”.

 You find the chapter “Maintenance intervals” at the end of the document. The general maintenance (visual inspection, etc.) is also explained there.

In the chapter “Maintenance intervals” there is information on the maintenance intervals of the filter elements. But these are only recommendations. Depending on the application (multi-shift operation, dust generation, ...) it may be necessary for the operator to change the maintenance intervals.

In this chapter the maintenance work which is caused by wear caused during operation is described.

WARNING	
 	<p>Work on the open system entails the risk of electrical shock or accidental restart the system. Both pose a danger to life and limb. There is also a risk to the eyes if there is a direct view of the UV-C lamp.</p> <p>When cleaning and servicing equipment during the replacement of parts or when changing to another function, set the device to maintenance condition first (see chapter “Reset to maintenance state”).</p> <p>A recommissioning of the device must only occur if it is ensured that the device is functionally equivalent to the original state.</p> <hr/> <p>Dangers to life and limb when non-original spare parts are used Only original TEKA spare parts must be used.</p>

CAUTION	
	<p>Hazards to the respiratory tracts are possible.</p> <p>All maintenance work must only be carried out in well-ventilated rooms and while wearing an appropriate respiratory mask! We recommend: respiratory protection half mask DIN EN 141/143 protection level P3. For all maintenance work ensure a cautious handling of filter elements and components in order to avoid whirling up dust.</p> <hr/> <p>Notes regarding SARS-CoV-2 (Coronavirus)</p> <p>In relation with SARS-CoV-2, the german RKI (Robert-Koch-Institut) has published a section on its website with information on the disposal of waste:: https://www.rki.de/DE/Content/InfAZ/N/Neuartiges_Coronavirus/Hygiene.html</p> <p>Please note that the information provided there (e.g. on waste disposal) is updated from time to time. So always take into account the current status of waste disposal.</p> <p>We recommend: Stow the changed (filter) elements in tear-resistant and tightly closed plastic bags before disposal, so that contact is avoided in the further disposal process. Disposal can take place via the mixed waste / residual waste.</p>



 The operator is obliged to store and dispose of the collected dust in accordance with national or regional regulations. For all maintenance or cleaning work please refer to the applying environmental regulations. Pollutants and filter elements must be disposed of or stored according to the regulations as well. If you have any doubts, we recommend contacting a disposal contractor in your area.

7.1. Reset to maintenance state

- Switch off the unit. Unplug the mains plug. Secure the unit against unauthorized restarting during maintenance.
- After completion of all maintenance work the unit can be reconnected to the power supply.

7.2. Replacing the microfilter mats



The microfilter mats must be changed after a certain number of operating hours. The time depends on the amount of accumulated dust, and therefore cannot be determined beforehand.

	CAUTION
Whirling up dust is possible. The microfilter mat is a disposable filter element. Do not try to clean the filter element.	

- Release the protective grilles on both sides (suction grille and exhaust grille, see chapter 2.1). To do this, release the 4 screw connections of both grilles.
- Replace the microfilter mats with new ones.
NOTICE Only use TEKA spare filters. Otherwise the proper functioning of the unit is not guaranteed, and there is a danger to life and limb.
- Screw on the protective grilles again.

7.3. Replacing the UV-C lamp

	CAUTION
Risk of burns when touching the UV-C lamp. After switching off the system, wait 5 minutes before changing.	

	NOTICE	
Reduction of the UV-C light transmission is possible. Grease residues can burn into the glass elements. Do not touch the glass elements with your fingers. Use gloves.		

- Release the exhaust grille (see chapter 2.1). To do this, release the 4 screw connections. Remove the microfilter mat.
- There is another protective grille behind the microfilter mat. Also release this.
- Now carefully pull the UV-C lamp out from its holder.

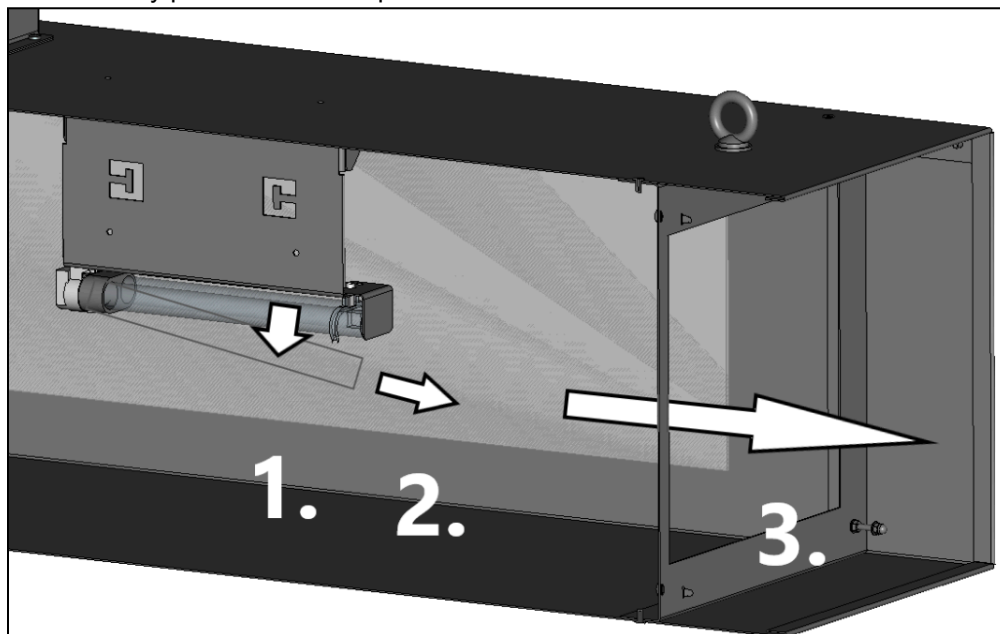



- Insert the new UV-C lamp.
NOTICE Only use TEKA spare parts. Otherwise the proper functioning of the unit is not guaranteed, and there is a danger to life and limb.
- Mount the inner protective grille, the microfilter mat and the exhaust grille again.

8. Dismantling / Disposal

Only authorised personnel may disassemble the machine.

	WARNING
	<p>Dangers arising from electricity. Before the dismantling of the machine it has to be disconnected from the power supply and all supply lines.</p>

	CAUTION
	<p>Whirling up dust is possible due to the deposited dust. During all work a suitable respiratory protection and protective clothing have to be worn.</p>

	The operator is obliged to store and dispose of the collected dust in accordance with national or regional regulations.
---	---

9. Diagnostics and troubleshooting

A list of possible system errors is provided in the table.

A recommissioning of the device must only occur if it is ensured that the system is functionally equivalent to the original state. Repairs may only be carried out by TEKA personnel or, after consultation with TEKA GmbH, by the personnel authorised by the operator.

Adhere to the instructions in the chapter "Safety instructions" and "Maintenance" when carrying out any repairs. If in doubt, contact our TEKA service department:

Tel: +49 2541-84841-0
E-mail: info@teka.eu

Fault	Cause	Removal
System does not start.	Plug power supply is missing or incorrectly inserted.	Plug connector check power supply / plug in correctly. Further informations see chapter "Operating the system".
	No power at outlet.	Check the mains, remove error if possible.
Suction power too low	Filter element is saturated.	Replace the filter package, dispose of old filter properly!
	Suction line contracted.	Check and fix.
	Exhaust line contracted.	Check and fix.

10. List of spare parts

	WARNING
	Dangers to life and limb when non-original spare parts are used. Only original TEKA spare parts must be used.

Filter element	Article no.
Microfilter mats (2 pieces): for version "Smart Basic" for version "Smart WiFi"	100311 100312
Other parts	Article no.
UV-C lamp	100310

11. Technical data

Version		ViroLine Smart Basic	ViroLine Smart WiFi
Supply voltage	V	230	230
Frequency	Hz	50	50
Type of current	Ph	1	1
Engine power	kW	0,027	0,038
Air flow volume max.	m³/h	400	700
Protection class		IP54	IP54
ISO class		F	F
Width	mm	1000	1000
Depth	mm	290	345
Height	mm	290	345
Weight	kg	16	19,5
Sound pressure level	dB(A)	43	43
Allowed ambient temperature	°C	+5 to +35 (during operations) -10 to +40 (during transport and storage)	
Allowed max. humidity	%	70	

12. EC declaration of conformity

according to the Machinery Directive 2006/42/EG, Annex II, 1 A

TEKA Absaug- und Entsorgungstechnologie GmbH

Millenkamp 9, D-48653 Coesfeld

Tel.: +49 2541-84841-0

E-Mail: info@teka.eu

Internet: www.teka.eu

Designation of the device: ViroLine Smart

We hereby declare under our sole responsibility that the product mentioned above, from the serial number A22600010011001 resp. P57300010011001 on, conforms to the following directives:

Machinery Directive: 2006/42/EG

Electromagnetic Compatibility: 2014/30/EU

RoHS directive: 2011/65/EU

This declaration will become void if the device is exposed to modifications that are not approved by the manufacturer in written form.

Authorized representative for the technical documentation:

TEKA Absaug- und Entsorgungstechnologie GmbH, Millenkamp 9, D-48653 Coesfeld

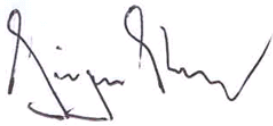

(Jürgen Kemper, managing director)

Coesfeld, 3rd January 2023



13. Training protocol

Designation of the device: ViroLine Smart

(This form can be used by the operator to document the training of the employees. Training should be performed by authorized personnel only. Refer to the instructions in Chapter "Safety Instructions")

By his signature, the employee confirms that he has been instructed regarding the following items:

Instruction	completed
Description of the device	
Operation and application of the device	
Explanation of the safety instructions	
Behavior in case of fire	
Explanation of the operation elements	
Change and dedusting of the filter elements	
Appropriate disposal	
Maintenance works / Maintenance intervals	

Name of the employee (legible)	Signature

Introduction through (legible):	
Signature:	

14. Maintenance intervals

14.1. Usage-related maintenance

The described maintenances become necessary through the demands of the system operations. The maintenance intervals are recommendations. Depending on the application (multi-shift operation, dust generation, ...) it may make sense for the operator to change the intervals of maintenance, replacing and cleaning.

Maintenance work must always be documented by means of a protocol.

The approach of the maintenance measures is described in chapter "Maintenance".

Maintenance work	Chapter	Maintenance interval	
		recommended by TEKA	determined by the operator
Replacing the microfilter mats (or check the degree of pollution)	7.2	semi-annually	
Replacing the UV-C lamp	7.3	after 9000 operation hours (this is absolutely necessary as the lamps lose intensity over time)	

14.2. General maintenance

The described maintenances are independent from the demands of the system operations.

The operator is obliged to carry out repeated inspections and functional tests according to national regulations. If not otherwise covered by national regulations, the described maintenance intervals must be respected.

Maintenance work must always be documented by means of a protocol.

Maintenance work	Chapter	Maintenance interval
Visual inspection of the device	14.2.1	weekly
Functional test of the device	14.2.2	monthly
Electrical test of the electrical lines and earthing connections	14.2.3	annually

14.2.1. Visual inspection of the device

Visual inspection: Observation that there are no visible safety-related defects.

	WARNING Danger arising from the ready to operate condition of the device. Follow the procedure as described in the chapter "Set to maintenance state".
---	--

The following steps must be carried out in the course of the visual inspection:

- Ensure that all parts are firmly connected.
- Check all metal parts for corrosion or damages / changes of the coating.
- Visual inspection of the control and operating elements as well as the outside running cables for damages.

14.2.2. Functional test of the device

	NOTICE Possible material damage due to faulty condition of the unit. Carry out a visual inspection before the functional test of the device as described in the previous chapters. The work as described in the chapter "Commissioning" must be finished.
--	--

The following steps must be carried out in the course of the functional test:

- Switch on the device.
- Pay attention to extraneous noises or vibrations during the device's operation.
- Check if the collection of the ambient air is sufficient. (Visual inspection).

14.2.3. Electrical test of the electrical lines and earthing connections

	WARNING Danger arising from electricity. The operator is responsible for ensuring that all work on electric components is carried out by authorised and qualified personnel.
---	--

The device is subject to regular electrical checks by the operator of the device, and are subject to national standards of the different countries.

The here recommended maintenance interval complies with the in Germany applying "Regulation 3 of the German Social Accident Insurance - Electrical plants and equipment" (formerly known as BGV-A3).

The check must only be carried out by a qualified electrician or a person trained in electrics using suitable measuring and test devices. The scope of testing and the methods must be in line with the respective national standard. All contacts in the control cabinet must be checked for tight fit, and must be readjusted if necessary.